

A STUDY ON VASCULAR RECONSTRUCTION BY FLOW VISUALIZATION*

MASARU ESAKI

*1st Department of Surgery, Nagoya University School of Medicine
(Director: Prof. Yotaro Iyomasa)*

ABSTRACT

Occlusion after reconstructive vascular surgery in the peripheral vessels is supposed to be caused by thrombus formation due to hemodynamic changes at anastomotic sites. Flow patterns which are changed at anastomotic sites due to alteration of vascular lumen or flow course are observed in this study. Since vascular anastomotic site easily fell into constriction, special attention was given to flow through stenotic orifices and through branched tubes for a study of bypass graft in this study.

The mixture of glycerin and water was made to have approximately the same viscosity and specific gravity as the blood. Fine aluminum powder was added to this mixture in order to demonstrate flow lines. The solution was made to run in glass tubes which modify vascular stenosis and bypass graft. Slide projectors were used to pass the light through a slit properly focused upon the flow, the flow field could be visualized and flow patterns were observed.

Eddy and stagnation zones were formed in the marginal areas of the post-stenotic regions and at the junction of bifurcation in the main tube in which flow was not running.

The glass models were attached extracorporeally to the canine abdominal aorta to observe the sites of thrombus formation. Thrombus was prominently attached in the areas of stagnation and eddy currents as observed above.

The experiments brought about a result that vascular reconstruction should be made without stenosis and the space of non-flowing at bypass graft.

INTRODUCTION

A number of workers have investigated flow lines in tubes. Dynamics of blood flow was observed radiographically in the canine aorta with contrast media injected through a catheter¹⁾. It is, however, very difficult to follow flow patterns in the living animal, therefore certain types of studies must be performed in models. Flow visualization is an important tool in fluid mechanics research, and the means of visualizing flow have been used in engineering and chemistry. This technique has been adapted for the study of

江崎 優

Received for publication July 19, 1973.

* An outline of this study was presented at the 12th and 13th Congresses of Japanese College of Angiology on October 29, 1971 and on October 28, 1972 and at the 162nd Congress of Tokai Geka on September 17, 1972, and also in Vol. 12 No. 3 of The Journal of Japanese College of Angiology on May 25, 1972.

flow patterns in models designed to simulate flow conditions in cardiovascular channels. Hemodynamic phenomena of vascular reconstructive surgery, particularly the location of disturbances, were observed by means of models in which a steady two dimensional laminar flow of a Newtonian fluid, such as water, was made to run²⁾. Bunting and Kreith reported a flow visualization method for three dimensional incompressible fluid flow³⁾.

Clinical results with arterial grafts to bypass an obstructive segment in one of the peripheral arteries have been somewhat discouraging. A graft, although it bridges a vascular defect, sometimes fails to provide an adequate anatomicophysiological conduit for the blood. Flow patterns are changed at anastomotic sites due to alteration of vascular lumen or flow course. Phelan and Herrick⁴⁾ presented some experimental data regarding flow patterns in glass models and discussed the findings in relation to arterial grafts and vascular anastomoses.

The purpose of this study is to demonstrate flow patterns and thrombus in glass tubes which modify vascular stenosis and bypass graft and to discuss a relationship between flow patterns and thrombus formation.

EXPERIMENTAL PROCEDURE

1. Streamlines were observed under the following examinations;

Preparation of solution and glass tubes

Solution

Two parts of glycerin were mixed with three parts of water to have approximately the same viscosity and specific gravity as the blood. A liquid of alcohol (70 percent) containing fine aluminum powder (filtered through meshes of 0.074 mm) was added to this mixture in order to demonstrate flow lines. The viscosity and the specific gravity of this solution at room temperature of 20°C were 3.7 centipoise and 1.09, respectively.

Glass tubes

Several glass tubes with inner diameter of 10 mm and 30 cm long were made in such a manner as to simulate a vascular anastomosis.

a. straight stenotic tubes

Glass tubes were formed with a moderate or steep narrowing to about one fourth or one half reduced in diameter in its midportion (Fig. 1).

b. branched tubes

Glass tubes were branched in its midportion. The angle and the diameter of the branched tubes were 30, 60 and 90 degree, and 5, 7 and 10 mm, respectively (Fig. 2).

Methods

The solution was permitted to flow through these tubes and was regulated

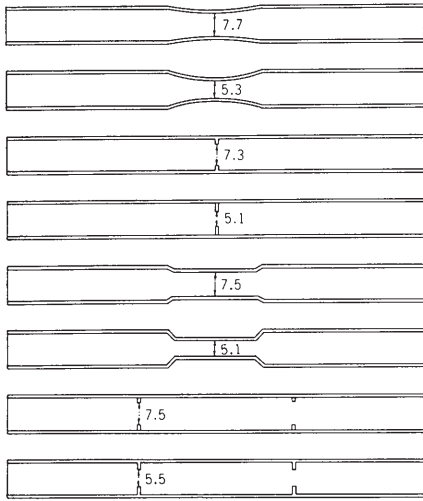

FIG. 1. Glass tubes of 300 mm long and 10 mm of the inner diameter. Figures show the inner diameter of the stenotic sites.

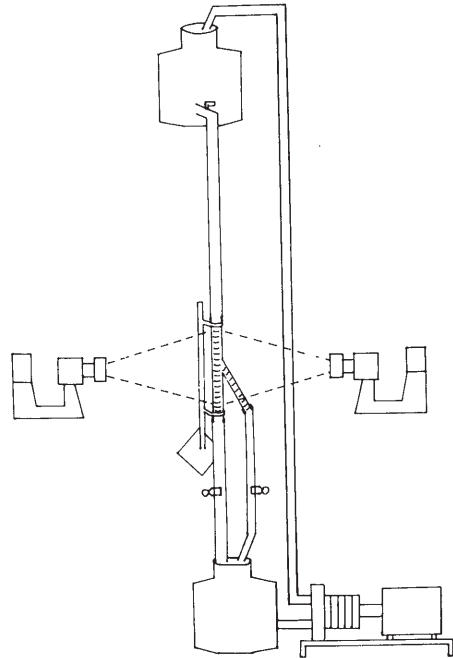

FIG. 3. Diagram of the experiment.

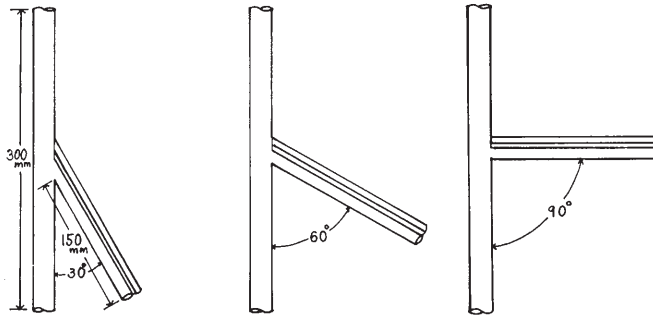

FIG. 2. Branched glass tubes. The inner diameter of the main tube is 10 mm and of the branched tube is 10, 7 or 5 mm.

at the rate of between 250 and 680 ml per minute.

Slide projectors were used with a slide on which a fine line was etched in order to pass a thin plane of intense light through the flow field. With the light passing through the slit properly focused upon the flow, the flow field could be visualized (Fig. 3).

Photographs were taken against a black back ground with F8 and 1/8 sec and were developed in hypersensitivity of ASA 3200.

2. The following examinations were performed to observe the sites of thrombus in glass tubes.

Mongrel dogs of approximately 10 kg body weight were anesthetized by intraperitoneal injection of 30 mg/kg of pentobarbiturate. The glass tubes were connected extracorporeally to the canine abdominal aorta, and were taken off in ten to thirty minutes to observe the sites of thrombus formation.

RESULTS

In all photographs the flow enters from the left.

Straight stenotic tubes and flow patterns

Flow patterns were little changed before and beyond the moderate narrowing of about one fourth reduction in diameter as depicted in Fig. 4. In the

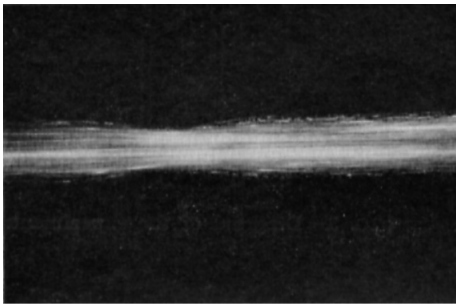

FIG. 4. The inner diameter of the stenosis is 7.7 mm. Flow rate is 360 ml/min. Flow pattern is little changed beyond the stenosis.

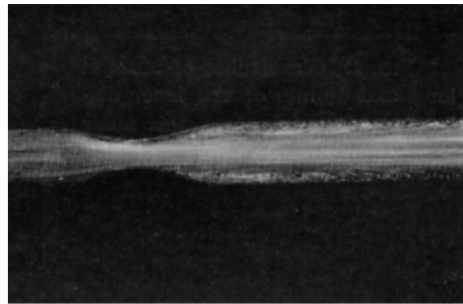

FIG. 5. The inner diameter of the stenosis is 5.3 mm. 360 ml/min. Eddy is formed in the post-stenotic marginal area.



FIG. 6. Steep stenosis. The inner diameter of the stenosis is 5.1 mm. 300 ml/min. Eddy is in the poststenotic marginal area. Stagnation is observed just distal to the stenosis proximal to the eddy currents.

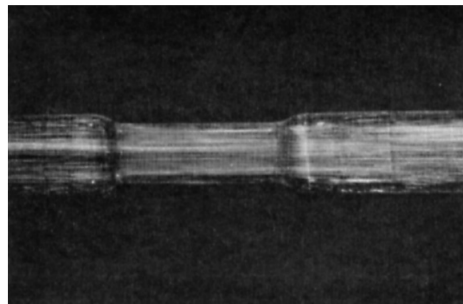

FIG. 7. Segmental stenosis with the inner diameter of 7.5 mm. 300 ml/min. Flow pattern is little changed in the poststenotic marginal area.

case of about fifty percent moderately reduced narrowing, eddy was formed in the marginal areas of the poststenotic region as shown in Fig. 5. In the steep narrowing to about fifty percent reduction, eddy was formed at poststenotic region and stagnation was found proximal to the eddy currents, that is, just beyond the narrowing as shown in Fig. 6.

In the case of long and relatively light degreed narrowing which modifies narrower graft, stagnation was somewhat observed in the expanded area beyond the narrowing as in Fig. 7. If the diameter of the narrowing was reduced to about fifty percent, eddy was formed in the relatively long area of the expanded region and stagnation was observed proximal to the eddy as in Fig. 8.

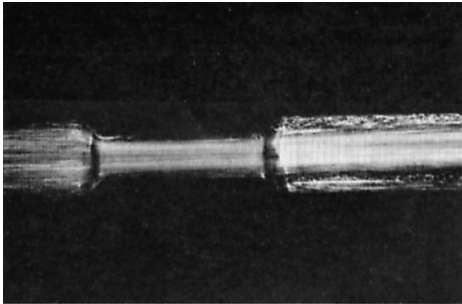

FIG. 8. Segmental stenosis of the inner diameter of 5.1 mm. 300 ml/min. Eddy is formed in the poststenotic marginal area.

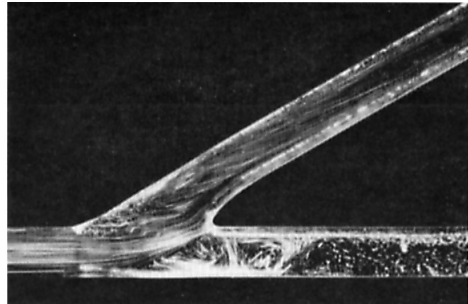

FIG. 9. The inner diameter of the main tube and the branched is both 10 mm. The angle of the branch is 30°. Flow was not running in the main tube distal to bifurcation. 550 ml/min. Eddy is formed in the proximal site of the branched main tube.

Branched tubes and flow patterns

Fig. 9 to 13 show streamlines in models which were supposed to bypass in one of the obstructed or stenotic segments of the peripheral vessels.

a) Flow to branched tubes

It can be seen from Fig. 9 that eddy occurred adjacent to the flow into the side tube in the main tube distal to bifurcation in which flow was not running and turbulence was observed in the proximal lateral site of the branched side tube. If flow was existent in the main tube distal to bifurcation, turbulence was found at the proximal lateral site of the main tube distal to bifurcation as depicted in Fig. 10. The size of the branched tubes had little effect upon the site and the quantity of eddy and turbulence. When the angle of the branched tube was large, flow line showed more turbulence just like a screw in the proximal site of the branched tube (Fig. 11).

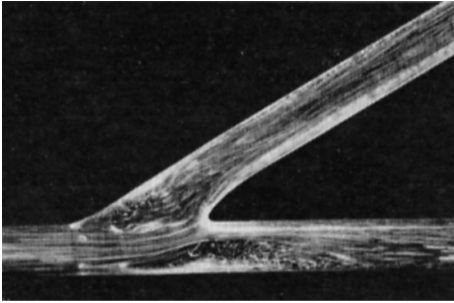

FIG. 10. About twenty percent of the total flow volume (550 ml/min) was running to the main tube distal to bifurcation. Turbulence is seen at the junction in the lateral site of the main tube distal to bifurcation.

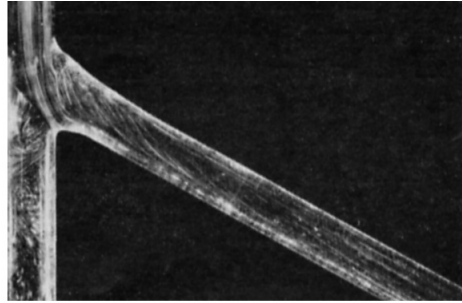

FIG. 11. The angle of the branched tube is 60°. 500 ml/min. Eddy is formed at the junction in the proximal site of the main tube distal to bifurcation. Turbulence of screw shaped is seen at the proximal site of the branched tube.

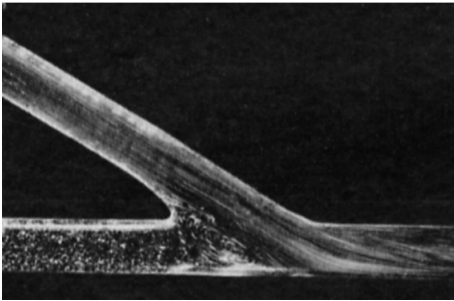

FIG. 12. Flow was not running in the main tube proximal to the confluence. 450 ml/min. Eddy is formed in the main tube in which flow was not running at the confluence.

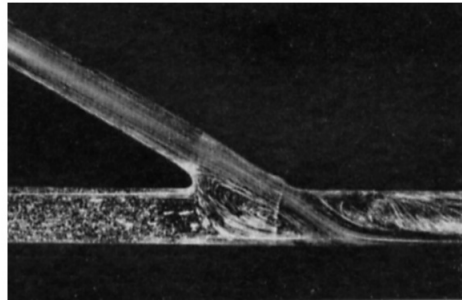

FIG. 13. The inner diameter of the branched tube is 7 mm. Flow was not running in the main tube proximal to the confluence. 350 ml/min. Eddy is formed in the main tube in which flow was not running. Turbulence is seen in the confluenced tube.

b) Flow from branched tubes

If flow came in only from a branched tube, eddy was formed at the junction in the main tube in which flow was not running, and turbulence was seen at the confluenced tube, as shown in Fig. 12. If flow came in from the smaller branched tube, eddy was formed at the junction in the main tube proximal to confluence and flow became more turbulent at the confluenced tube (Fig. 13).

Thrombus in tubes

When glass tubes were attached to the canine abdominal aorta, eddy and turbulence were seen at the areas as observed above. Thrombus was seen in ten to thirty minutes after the attachment of the tube to the canine abdominal

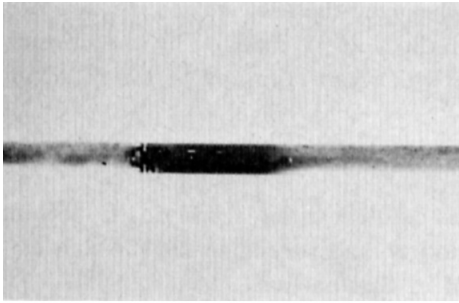

Fig. 14. Thrombus was markedly attached in the poststenotic region of the steep stenosis.

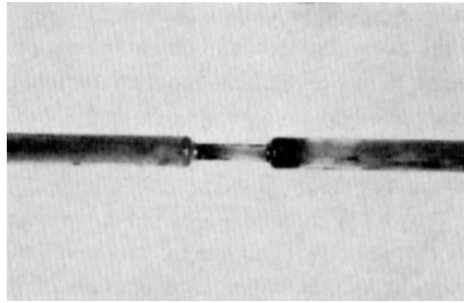

Fig. 15. Thrombus was markedly attached in the poststenotic region of the highly stenosis.

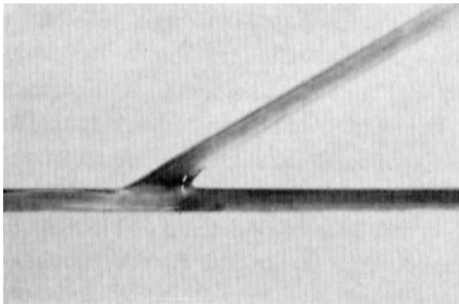

Fig. 16. Blood flow was from left to right. Main tube distal to bifurcation was obstructed distally. Thrombus was markedly formed in the main tube distal to bifurcation in which blood flow was not running. Thrombus was also seen in the proximal site of the branched tube.

aorta. The thrombus was prominently observed in the poststenotic areas of steeply or highly narrowed tubes as depicted in Fig. 14 and 15. In the case of bypass models, thrombus was attached more in the main tube distal to bifurcation in which flow was not running and also at the proximal site of the bypassed tube (Fig. 16).

DISCUSSION

Anastomotic techniques have shown much progress, though reconstructed vessels were easily occluded in the peripheral vessels. It is reasonable to suppose that this occlusion is caused by thrombus formation due to hemodynamic changes at anastomotic sites.

Several factors are involved in formation of thrombus after reconstructive surgery of peripheral vessels. In the present study, the author used glass models and dogs to explore some of the mechanical factors. Since vascular anastomotic site easily fell into constriction, special attention was given to flow through stenotic orifices and through branched tubes for a study of bypass graft.

Flow visualization method identifies laminar to turbulent flow by direct observation and in photographs. In hydrodynamics, any departure from

laminar flow is called turbulent flow. Whenever the section or direction of a fluid flow changes, the regular motion of the fluid is changed by the development of more or less local disturbances, which can take any of the following basic forms;

a) stagnation zones, in which the fluid is at rest and the surrounding fluid is moving very slowly.

b) eddy formation zones, in which the fluid contributes practically nothing to the flow in the general direction of motion, and secondary flow which consequently causes the interchange of fluid in these zones.

The author observed eddy in the marginal areas of the poststenotic region of steep and highly degressed narrowing and stagnation just distal to the narrowing proximal to eddy currents in the experiments with straight tubes.

Rodbard⁵⁾ designed to observe streamline through constricted pipes with air. Turbulence was recognized beyond the narrowing. The high velocity at the narrowing may overbalance the viscous forces which maintain the laminarity of the flow pattern, and the stream will become turbulent. Immediately beyond the narrowing a small region of the wall was less in contact with air. The momentum of the converging stream extruded through the throat of the nozzle causes the stream filaments to continue to converge for a short distance.

In the branched models, eddies were created at the junction of bifurcation in the main tube in which flow was not running at outflow to the branched tube and at inflow from the branch.

Turbulence was observed at the proximal lateral site of the main tube distal to bifurcation, when flow was existent in the main tube distal to bifurcation. This phenomenon was explained in the term of boundary layer separation⁶⁾⁷⁾. The lower velocity distal to bifurcation implies a higher pressure. Slowly moving fluid near the boundary will tend to have its forward motion reversed if this pressure rise is sufficiently great. It seems advisable clinically to ligate a stenotic vessel to achieve maximal graft flow when some flow may persist through a very tight stenosis⁸⁾.

The steady fluid flow through axisymmetric converging tube was studied both theoretically and experimentally. A mathematical model for stenosis was established and an approximate solution for flow through a converging tube was obtained⁹⁾¹⁰⁾¹¹⁾. It was also examined for bifurcation models¹²⁾. The presence of eddy zones depends upon not only the vascular contour, but also the value of Reynolds number. When the Reynolds number is small, eddy zones are not formed at the moderate stenotic sites. In the case of the large Reynolds number peripheral eddy can occur in conjunction with an axial laminar flow. This is due to loss of kinetic energy of the flow into an expansion which results in inability to overcome the wall friction, hence a reverse flow occurs in the region of the wall. The experiments of Figures between 4 and 8 were performed under the Reynolds number of 187 to 344.

Wesolowski¹⁾ and Schmitz¹³⁾ and coworkers suggested that turbulent flow of blood might play a part in intravascular thrombotic formation. Hershey and Calman¹⁴⁾ pointed out that small fibrin thrombi could be precipitated from the blood as the result of the localized area of turbulence in poststenotic areas.

Malan and coworkers²⁾ stated that near rest state was a precondition for a thrombotic process. Fox and Hugh⁶⁾ described that thrombosis was facilitated by static zones which might allow the interaction of platelets and fibrin to form a mesh.

From the experiments of visualized flow stagnation and eddy currents were formed in the marginal areas of the post stenotic regions and at the junction of bifurcation in the main tube in which flow was not running. From the canine experiments thrombus was prominently attached in these areas of stagnation and eddy currents. The author believes that there is a better correlation between the occurrence of not only eddy but also stagnation and thrombus formation. Clinical results of reconstructive vascular surgery have shown relatively early occlusion in the case of worse run-off flow. This occlusion is supposed to be caused by stagnation.

SUMMARY

Reconstructive vascular surgery sometimes fails to obtain patency. The experiments were performed to pursue a cause of thrombus formation with glass models and dogs. Flow patterns were observed at the stenotic orifices and the branched tubes with flow visualization method. Eddy and stagnation occurred at the poststenotic regions of high degree and steep narrowing and also at the junction of bifurcation in the main tube in which fluid flow was not running. Thrombus was observed prominently at these stagnation and eddy formation zones in the experiments in which these glass tubes were attached extracorporeally to the canine abdominal aorta. From the results of the experiments, the author believes that thrombus is easily formed at eddy and stagnation formation zones. It is therefore advisable that vascular reconstruction should be made without stenosis and the space of non-flowing at bypass graft.

ACKNOWLEDGEMENT

The author thanks Prof. Dr. Y. Iyomasa for his interest and review and Dr. T. Takao for his guidance and cooperation.

REFERENCES

- 1) Wesolowski, S. A., Sauvage, L. R., Ping, R. S. and Fries, C. C., Dynamics of blood flow in graft disproportions and in normal blood vessels, *Surg. Forum.*, **6**, 227, 1955.
- 2) Malan, E., Noseda, G. and Longo, T., Approach to fluid dynamic problems in reconstructive vascular surgery, *Surgery*, **66**; **6**, 994, 1969.

- 3) Bunting, L. S. and Kreith, F., Flow-Visualization Method for Three-Dimensional Incompressible Fluid Flow, *Rev. Sci. Instrum.*, **34**, 447, 1963.
- 4) Phelan, J. T. and Herick, J. F., Some rheologic principles as applied to vascular surgery, Staff Meetings of the Mayo Clinic, **33**, 5, 108, 1958.
- 5) Rodbard, S. and Johnson, A. C., Deposition of Flowborne Materials on Vessel Walls, *Circ. Res.*, **11**, 664, 1962.
- 6) Fox, J. A. and Hugh, A. E., Localization of atheroma; A Theory Based on Boundary Layer Separation, *Brit. Heart J.*, **28**, 388, 1966.
- 7) Scharfstein, H., Gutstein, W. H. and Lewis, L., Changes of Boundary Layer Flow in Model System, *Circ. Res.*, **13**, 580, 1963.
- 8) Barner, H. B. and DeWeese, J. A., Blood flow in bypass grafts, *J. Thorac. and Cardio-vasc. Surg.*, **51**, 5, 667, 1966.
- 9) Forrester, J. H. and Young, D. F., Flow through a converging diverging tube and its implications in occlusive vascular disease, *J. Biomechanics.*, **3**, 297, 1970.
- 10) Lee, J. and Fung, Y., Flow in Nonuniform Small Blood Vessels, *Microvascular Res.*, **3**, 272, 1971.
- 11) Matunobu, Y., Fluid-Dynamical Aspects of the Blood Circulation, J. Jap. College of Angiology, **12**, 3, 155, 1972.
- 12) Stehbens, W. E., Turbulence of blood flow, *Quart. J. Exp. Physiol.*, **44**, 110, 1959.
- 13) Schmitz, E. J., Kanar, E. A., Sauvage, L. R., Storer, E. H. and Harkins, H. N., The influence of diameter disproportion and of length on the incidence of complications in autogenous venous grafts in the abdominal aorta, *Surgery*, **33**, 2, 190, 1953.
- 14) Hershey, F. B. and Calman, C. H., Laws of fluid flow and their application to vascular surgery, Atlas of vascular surgery, The C. V. Mosby Company, Saint Louis, 1967, p. 10.