

Fig 1. Okuzaki et al.

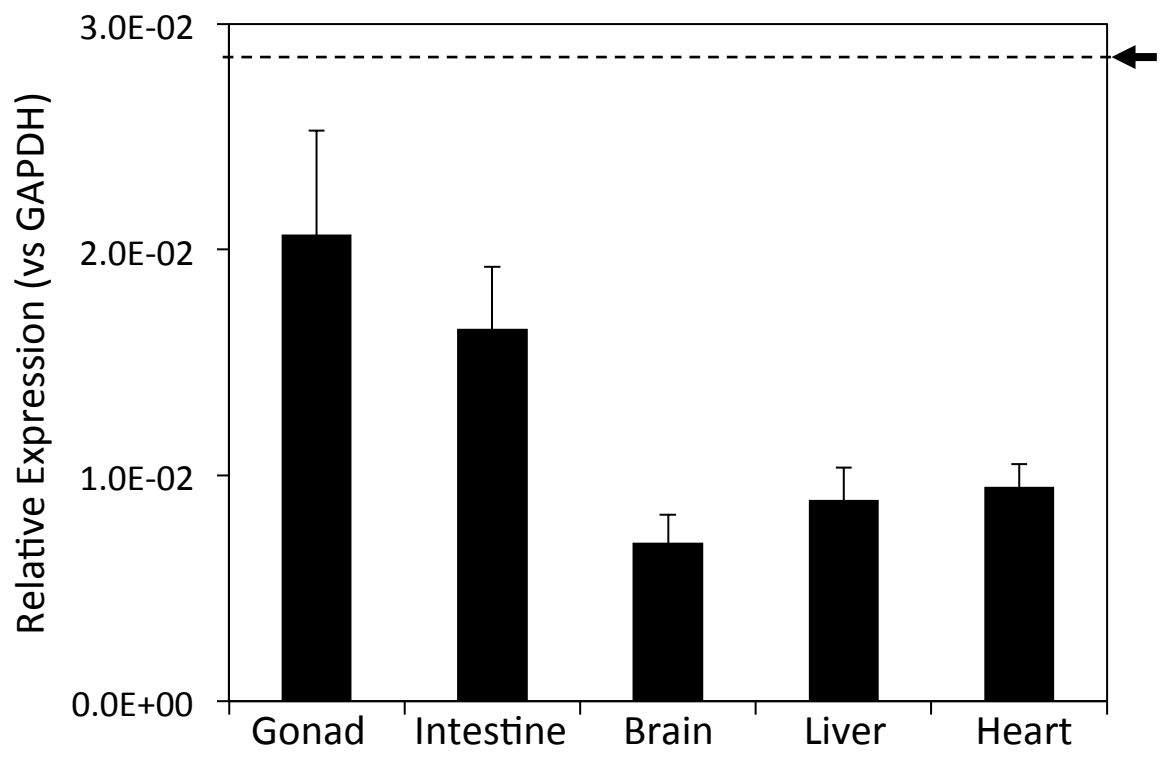

Fig 2. Okuzaki et al.

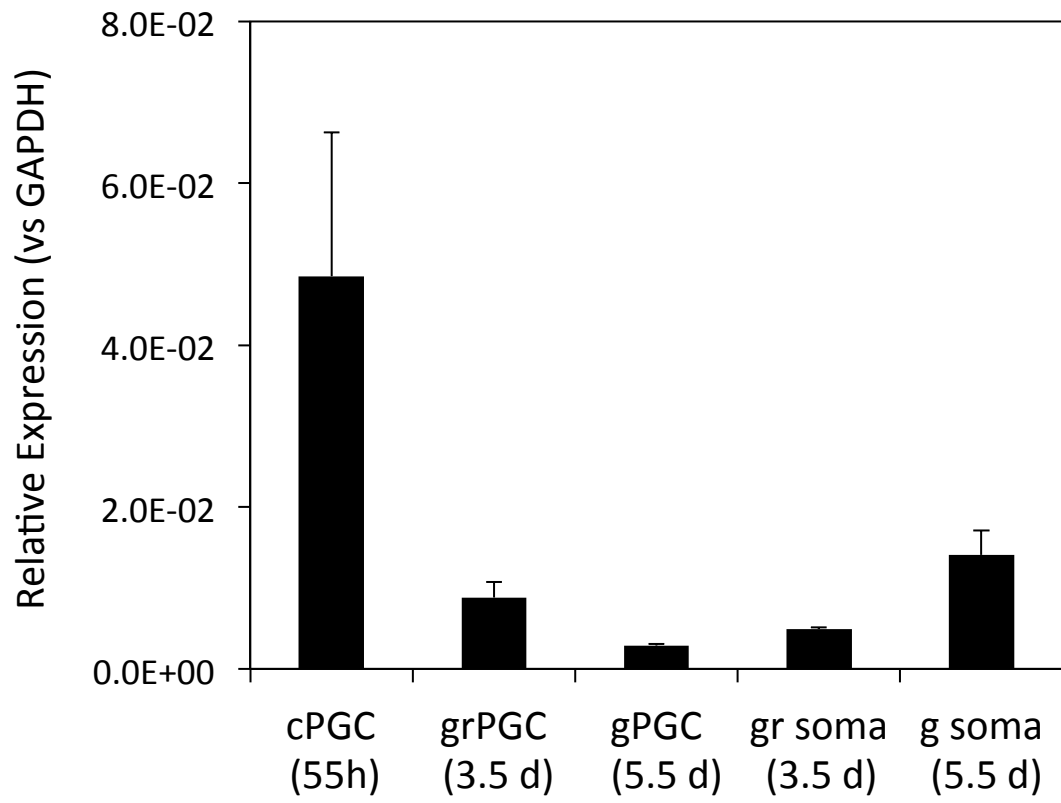

Fig 3. Okuzaki et al.

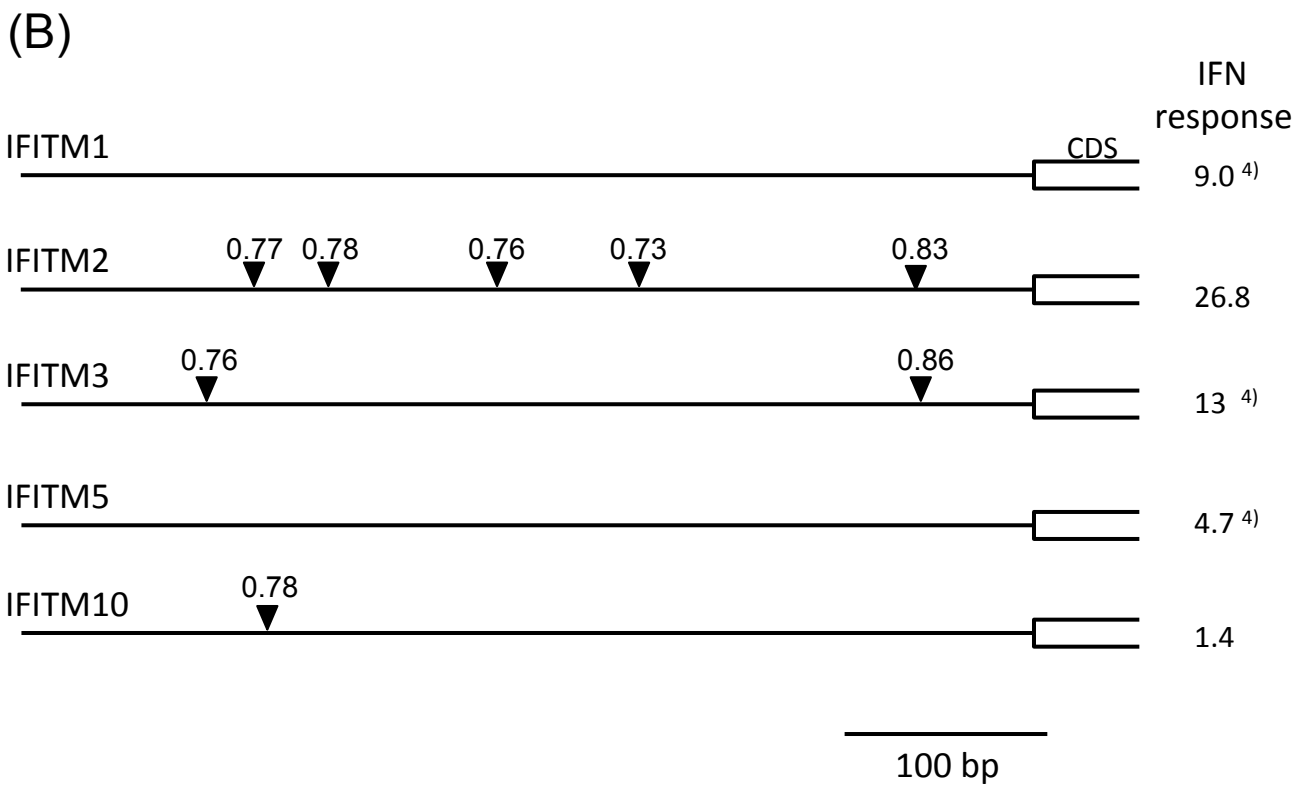
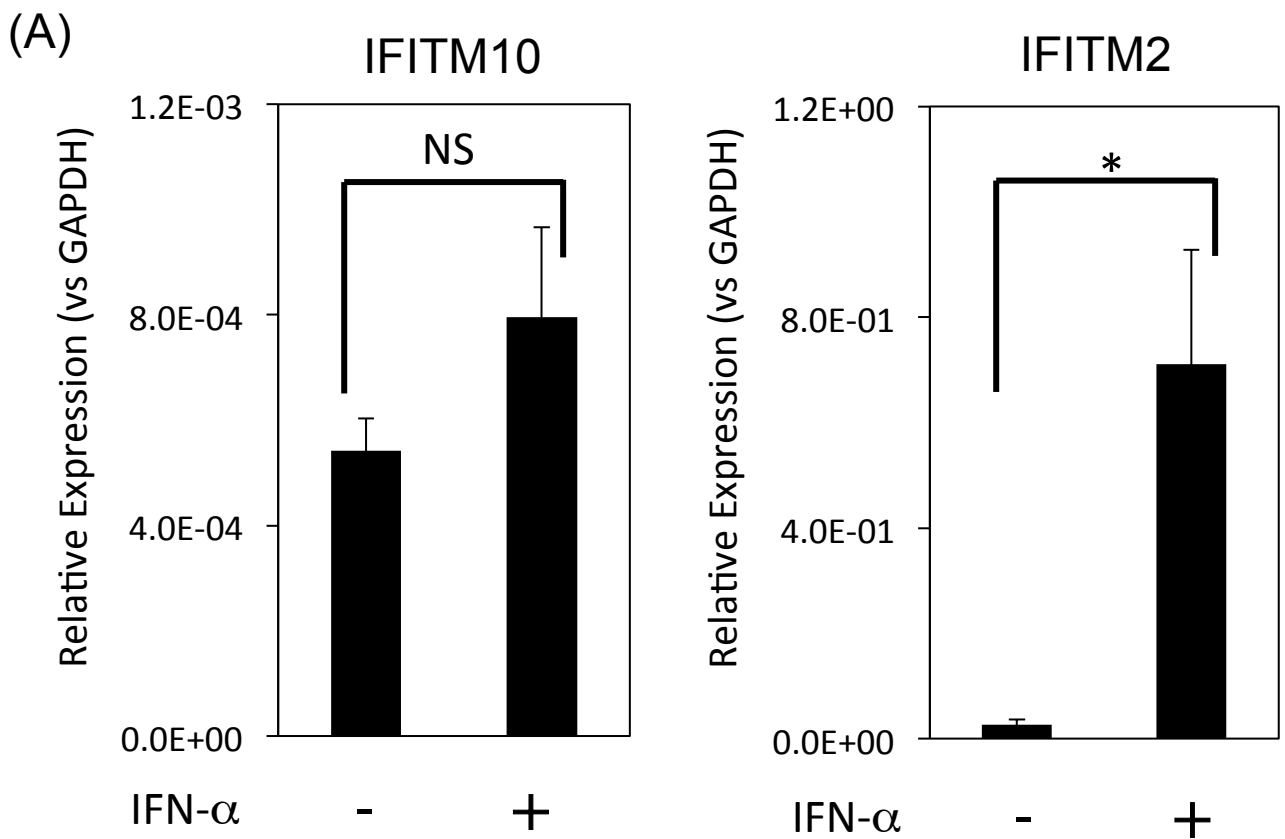
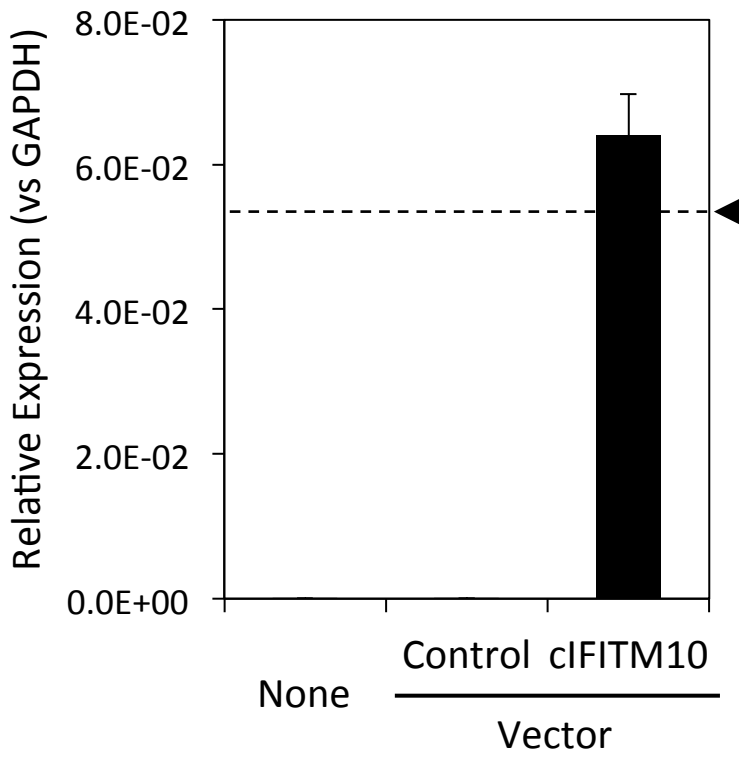

Fig 4. Okuzaki et al.

(A)



(B)

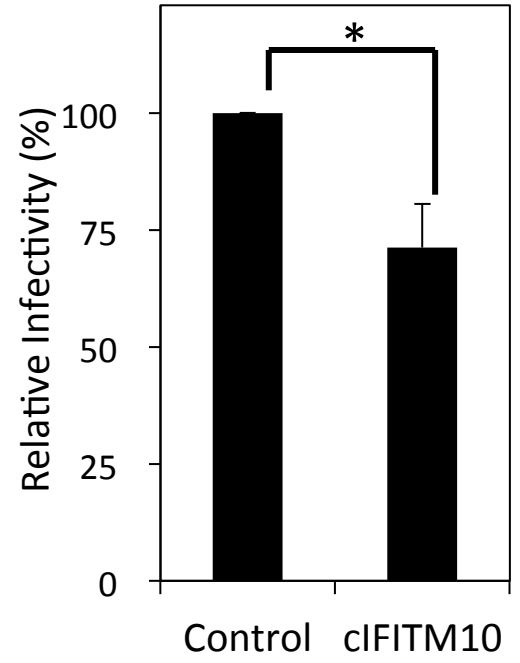

Fig 5. Okuzaki et al.

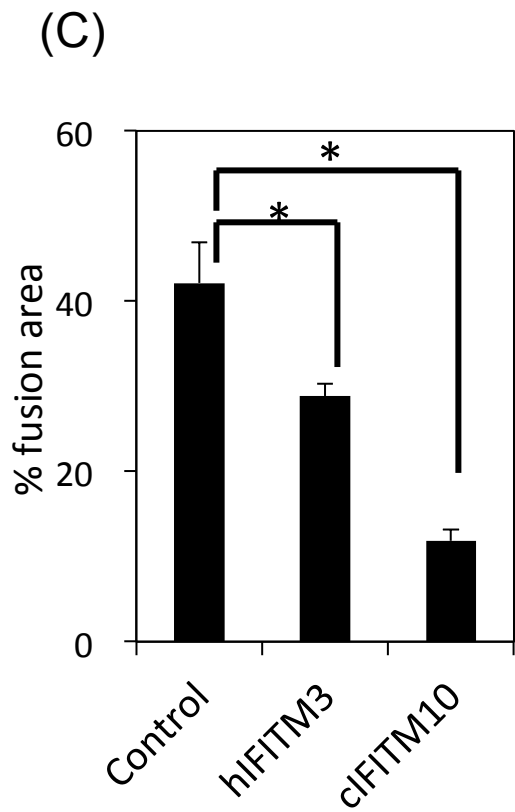
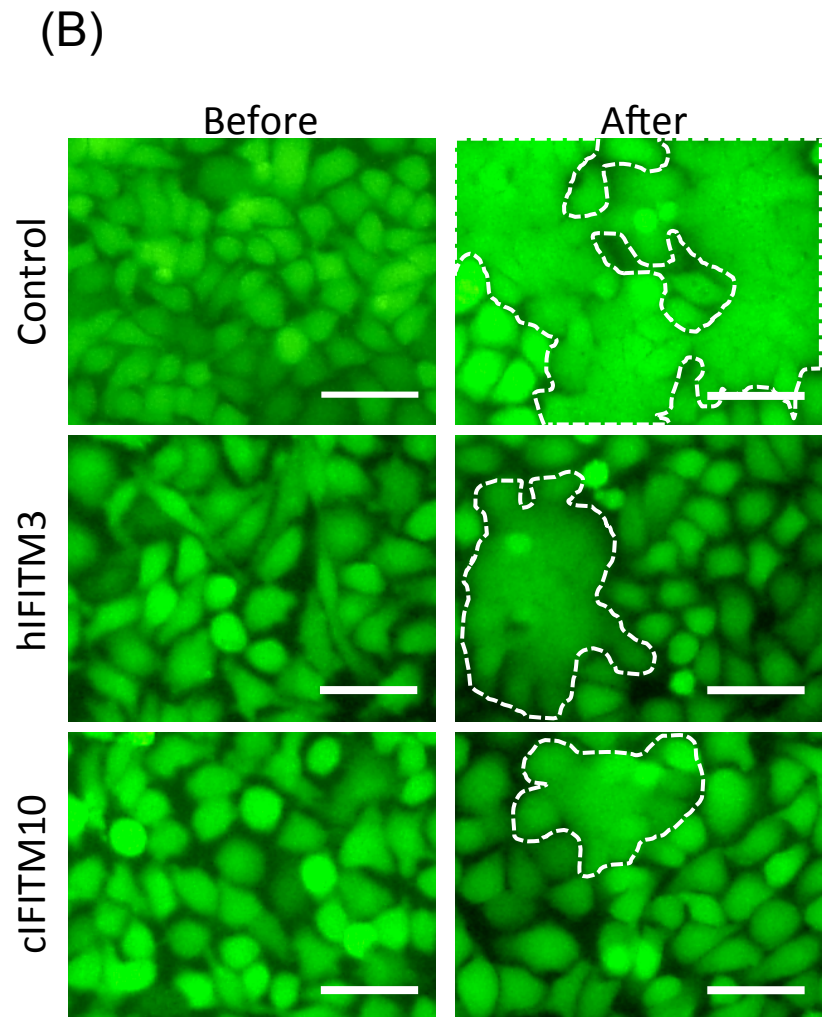
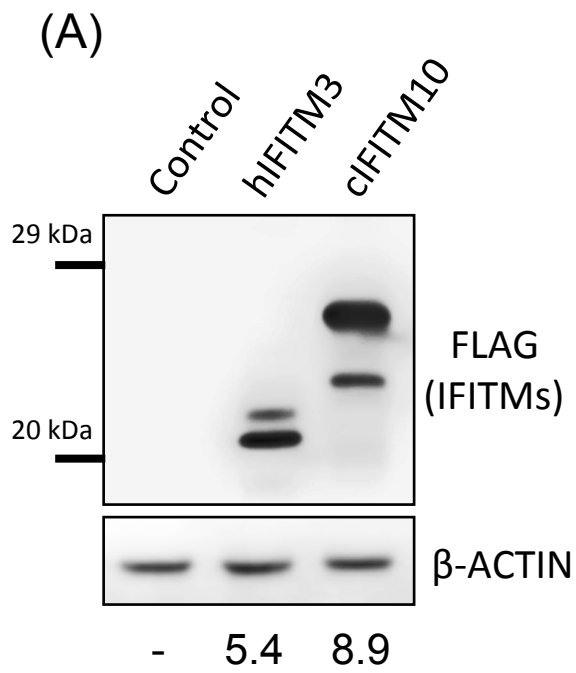
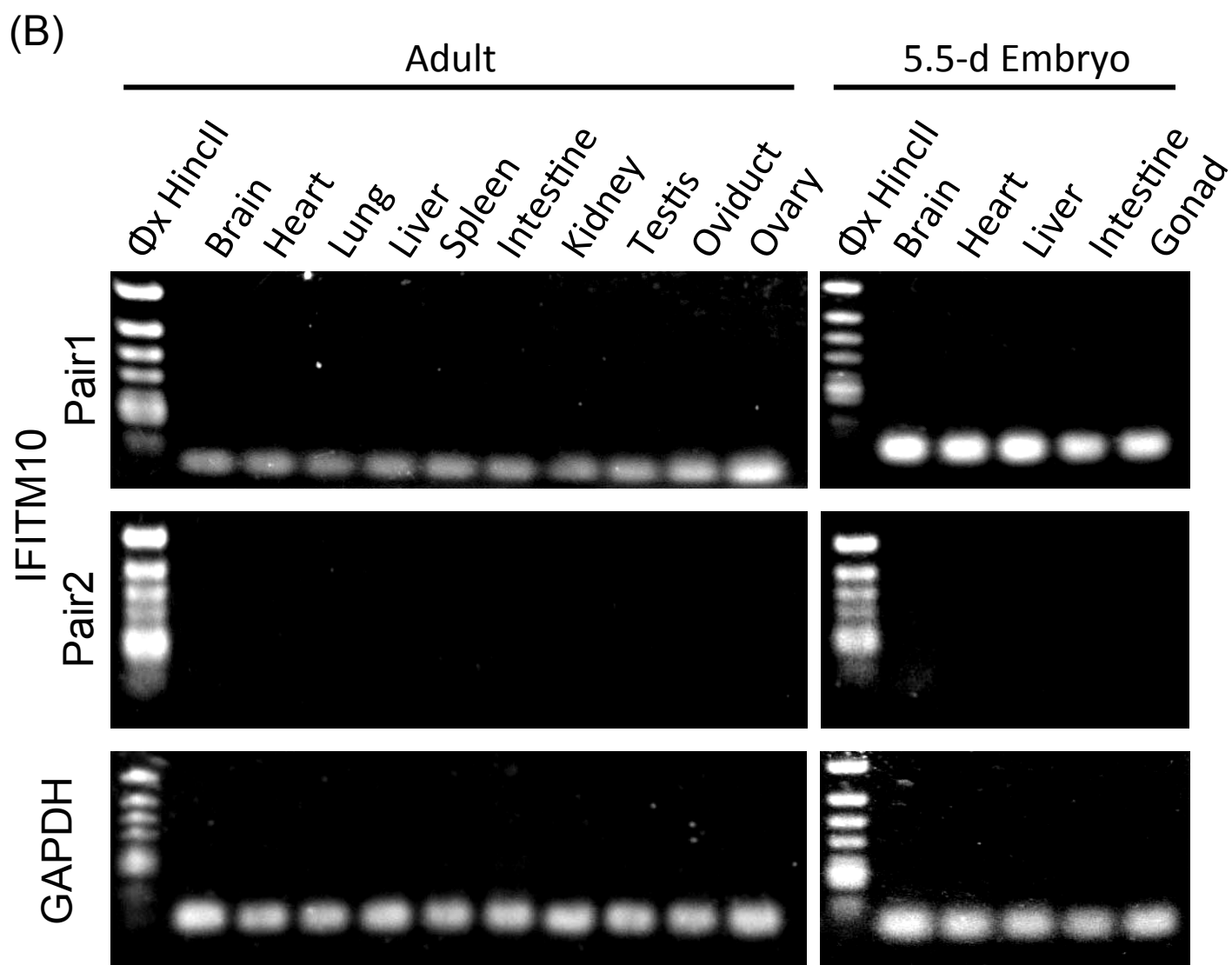
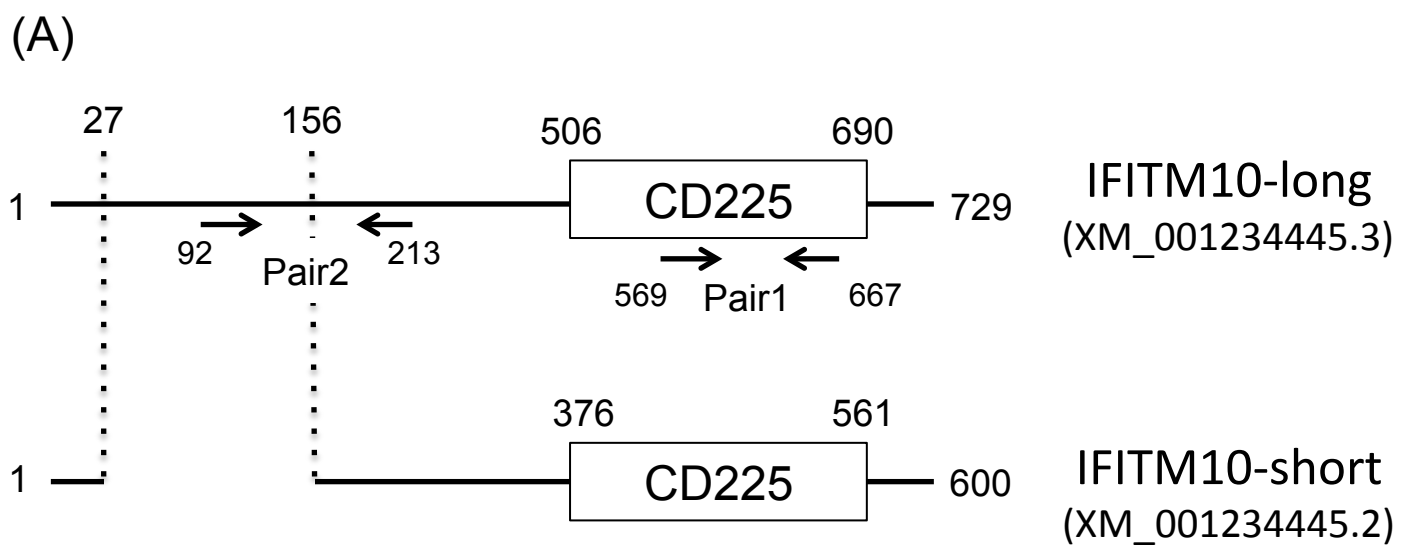
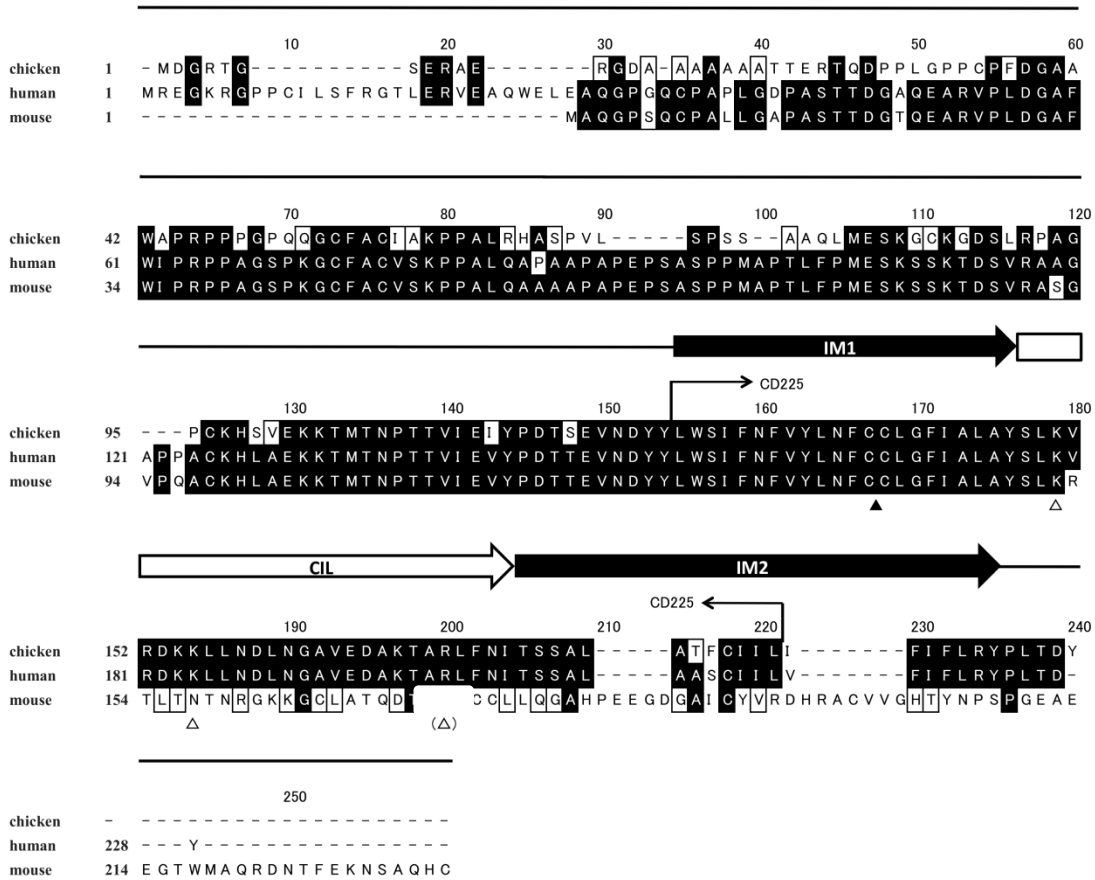

Fig 6. Okuzaki et al.



(A)



(B)

